 = 1 sq foot

General Setup Instructions

- Read entire setup instruction manual prior to unpacking parts and pieces.
- The setup instructions are created specifically for this configuration.
- Setup instructions are laid out sequentially in steps, including exploded views with detailed explanation for assembly.

Cleaning & Packing

- For Cleaning Metal, Plex, & Laminate Parts: Use a **MILD NON-ABRASIVE** cleanser and soft cloth/paper towel to clean all surfaces.
- Keep exhibit components away from heat and prolonged sun exposure. **Heat and UV exposure will warp and fade components.**
- Retain all provided Packing Materials. All provided packing materials are for ease of repacking & component protection.

Disassembly

- For loss prevention, tighten all set screws and locks during disassembly.

Assembly

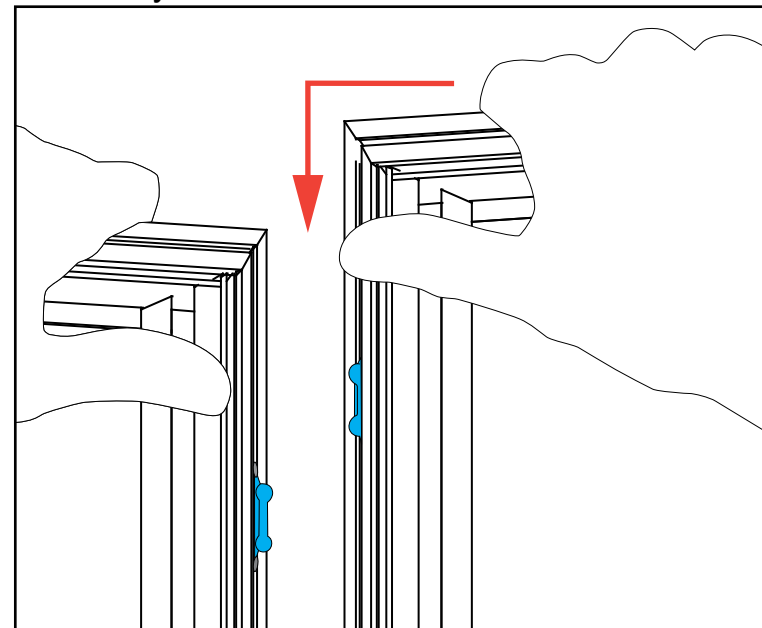

Assembly Cont'd

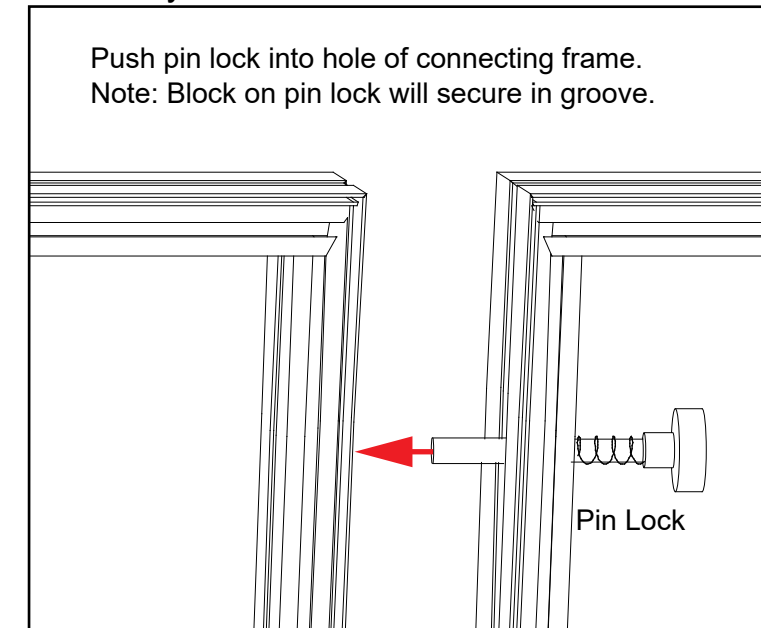

Side-by-Side Assembly

- 1) Frames: Place frames side-by-side with one higher than the other, then slide panel down to lock panels securely together.
- 2) Corner Connectors: Repeat Step 1 for installing corner connectors to frames.

Side-by-Side Disassembly

- 1) Pull pin lock outwards to disengage.
- 2) Pull frames upward and apart at the same time to detach.

SEG Graphic Installation

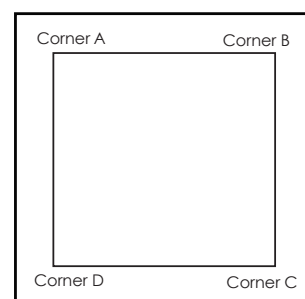

It is important to first insert graphic into each alternate corner, then to the sides of the frame. If this is not done, graphic will not fit into the frame correctly.



Step 1
Insert corner A. Turn edge of graphic so silicon welt is perpendicular to face of graphic. Insert narrow side of welt with fabric to outside into the channel. Repeat for other side of this corner.



Step 2
Repeat Step 1 for opposite corner C, then insert corner B, followed by corner D, to complete the installation of the corners.



Step 3
Once all corners are inserted, press one silicon edge into channel from corners and work toward the center. Make sure welt is fully inserted into channel. Continue until all sides are done. Smooth out edges of graphic.



To remove the graphic from the frame, locate the fabric pull tab. Gently pull up on the tab to remove the fabric.

CRATE PACKING

Item	Qty.	Description
1	1	14.125"w x 95"h Gravitee Panel
2	1	95"h Gravitee Corner Post
3	1	23"w x 95"h Gravitee Panel
4	1	30"w x 95"h Gravitee Panel
5	1	95"h Gravitee Corner Post
6	1	38"w x 95"h Gravitee Panel w/ Door
7	1	95"h Gravitee Corner Post
8	1	30"w x 95"h Gravitee Panel
9	1	28.5"w x 95"h Gravitee Panel
10	1	95"h Gravitee Corner Post
11	1	38"w x 95"h Gravitee Panel
12	1	95"h Gravitee Corner Post
13	1	30"w x 95"h Gravitee Panel
14	1	30"w x 95"h Gravitee Panel
15	1	46"w x 95"h Gravitee Panel
16	1	95"h Gravitee Corner Post
17	1	14.125"w x 95"h Gravitee Panel

Steps:

Refer to the Gravitee Assembly general information page.

- 1) Assemble Gravitee panels & posts [1] through [17] in numerical order as shown.

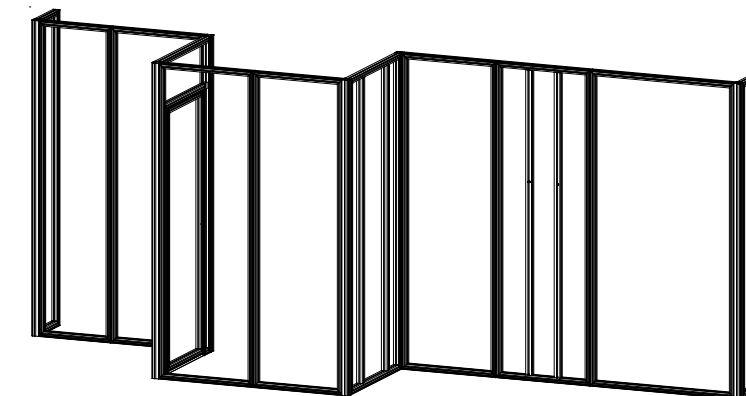

When assembled

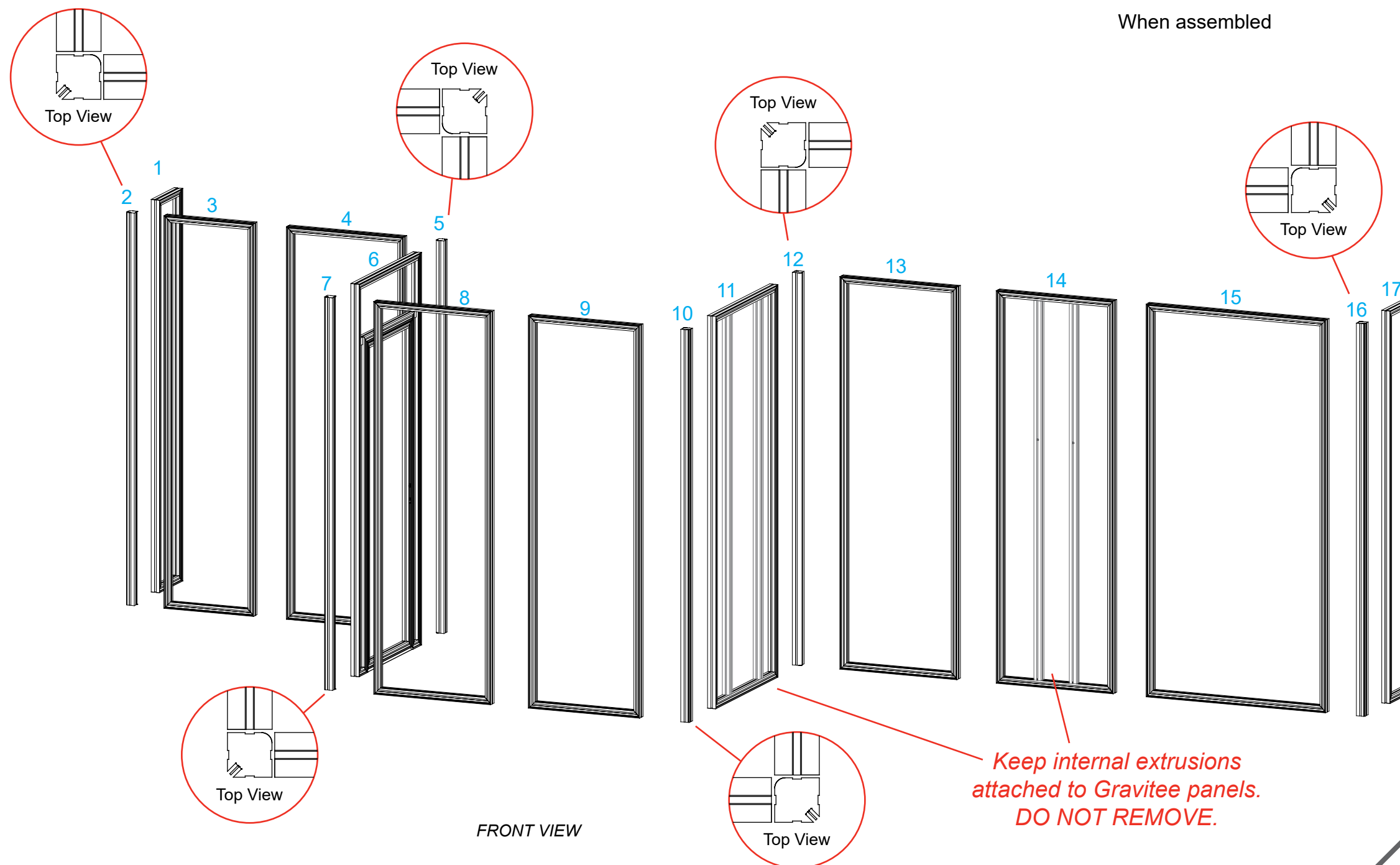

SEG Graphic Installation

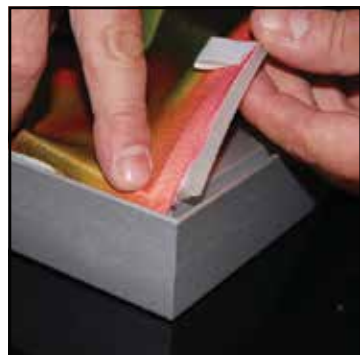
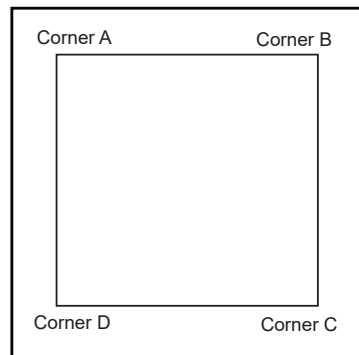

It is important to first insert graphic into each alternate corner, then to the sides of the frame. If this is not done, graphic will not fit into the frame correctly.

Step 1
Insert corner A. Turn edge of graphic so silicon welt is perpendicular to face of graphic. Insert narrow side of welt with fabric to outside into the channel. Repeat for other side of this corner.



Step 2
Repeat Step 1 for opposite corner C, then insert corner B, followed by corner D, to complete the installation of the corners.



Step 3
Once all corners are inserted, press one silicon edge into channel from corners and work toward the center. Make sure welt is fully inserted into channel. Continue until all sides are done. Smooth out edges of graphic.



Graphic Removal

To remove the graphic from the frame, locate the fabric pull tab. Gently pull up on the tab to remove the fabric.

Steps:

- 1) Apply SEG graphics to backwall panels as shown.
- 2) Connect lights to top of panels where indicated. See [Light Attachment](#) detail.

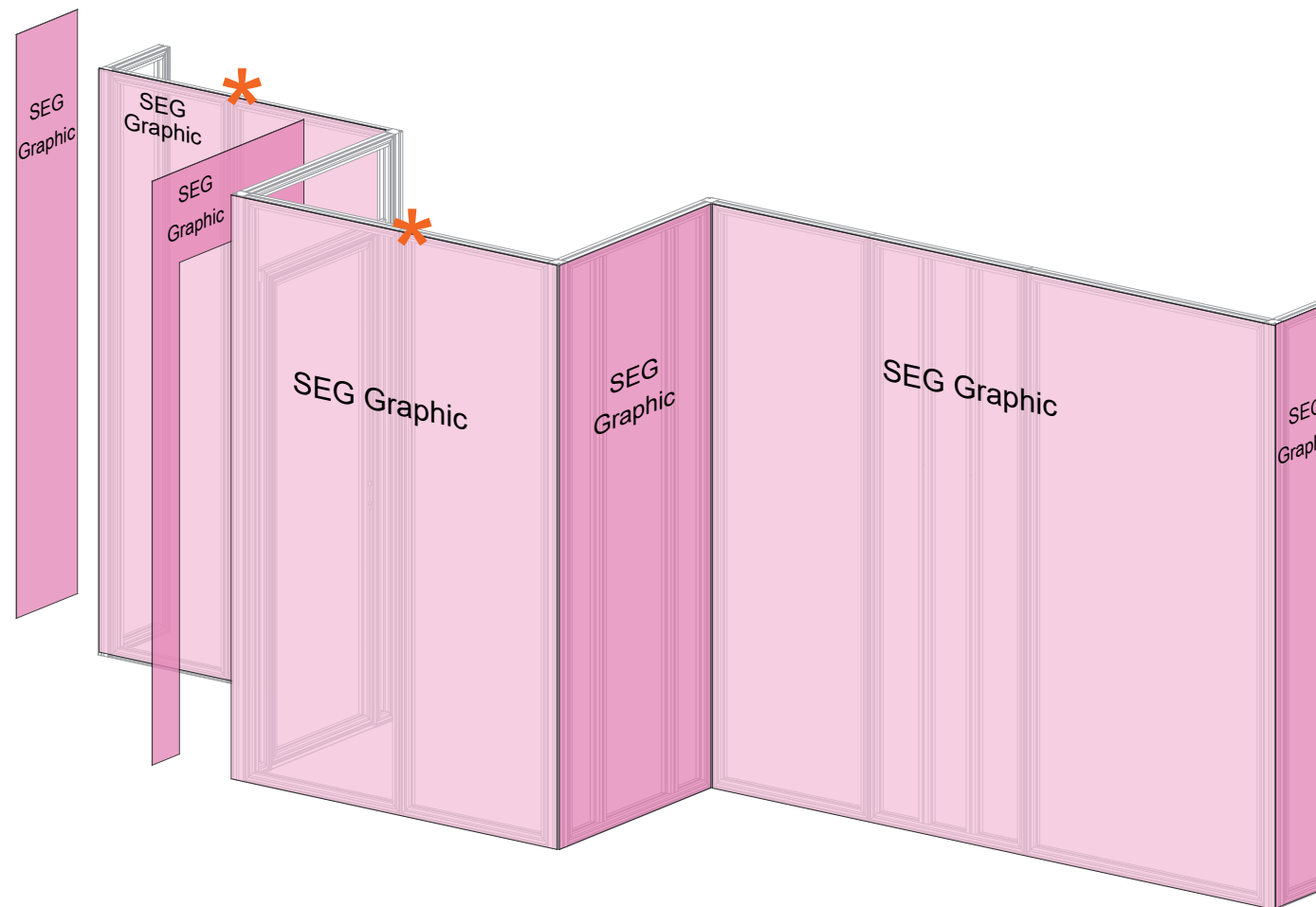

FRONT VIEW

* Light Attachment

Lock Clip into Groove of Horizontal Extrusion, then slide Light onto Clip.

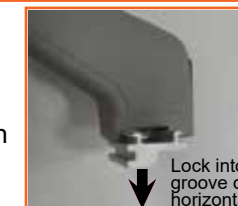

Slide light into light receiving hardware

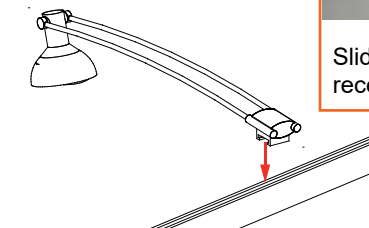

Item	Qty.	Description
--	4	37.75"w x 10"d Shelf w/ (2) 9" extrusions
--	1	Large Monitor Mount

- Steps:
- 1) Install Monitor Mount to vertical extrusions in panel [14].
See **Monitor Mount Attachment** detail.
 - 2) Attach Shelves to vertical extrusions in panel [11].
See **Shelf Attachment** detail.

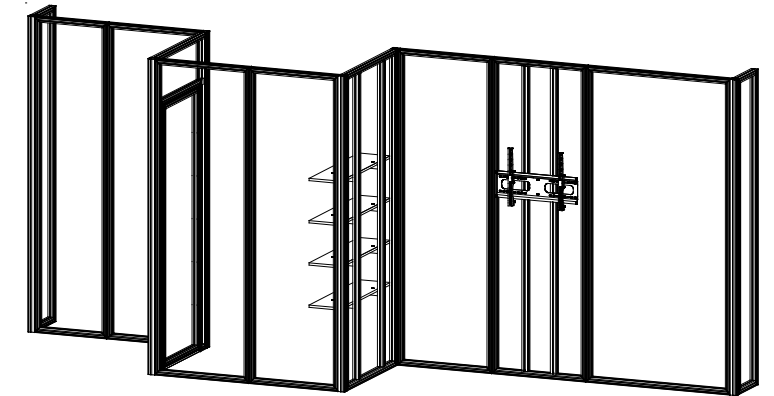

When assembled

*** Monitor Mount Attachment**

Slide V4 connectors into vertical channel of extrusions. Tighten set screws to secure.

V4 Connector

Stand-Off Barrels

S44

Screw Caps

Monitor Mount

Graphic

Attach Stand-off Barrels to V4 Connectors, then connect Monitor Mount to stand-offs using screw caps.

Note: Monitor mount installs over graphic.

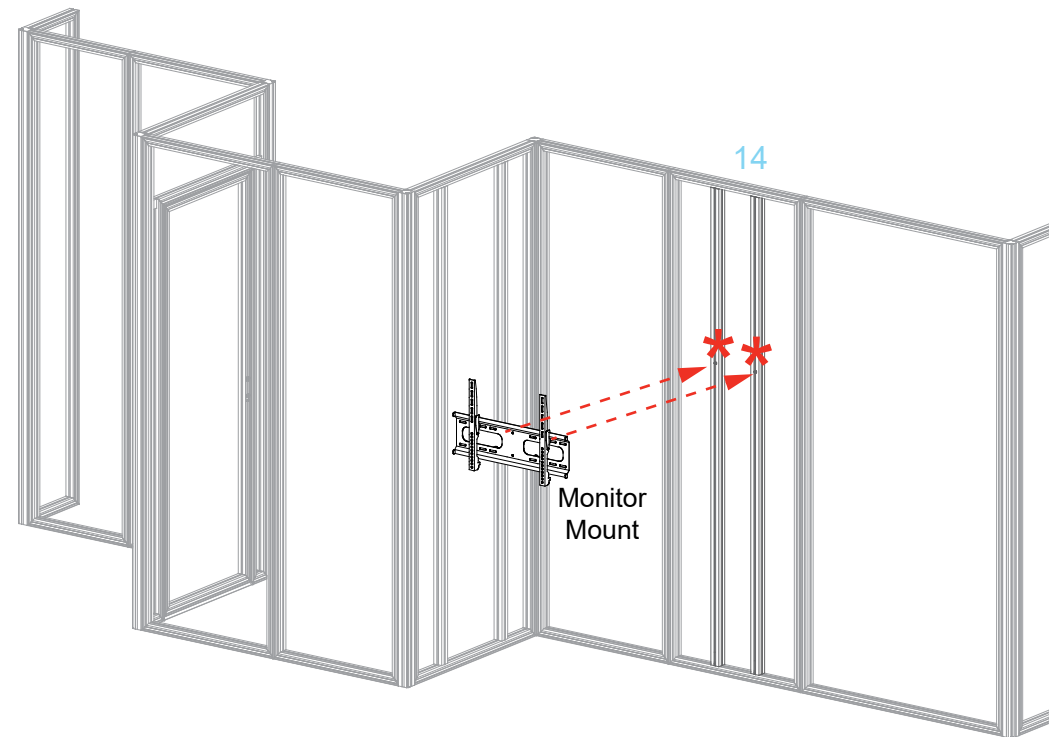

FRONT VIEW

*** Shelf Attachment**

Insert locks into groove of vertical extrusion & tighten setscrews.

Back of Shelf

Setscrews will face outward for ease of assembly

Lock

Setscrew

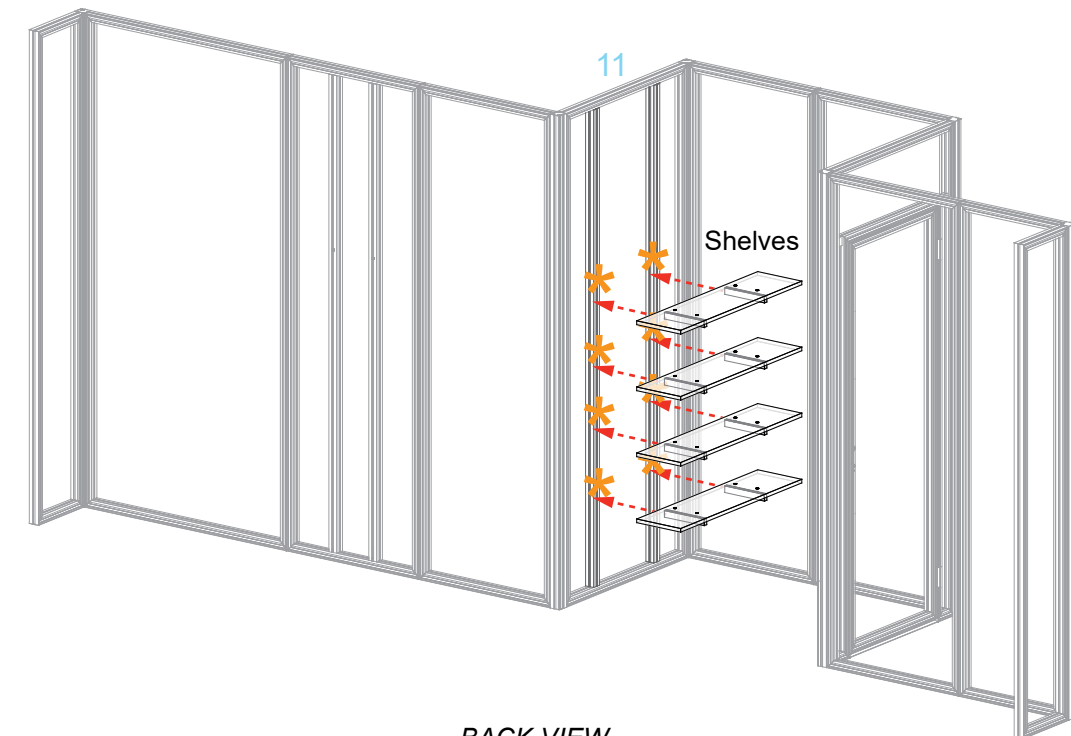

BACK VIEW

Item	Qty.	Description
25	1	38"h Gravitee Corner Post w/ Door Attachment
26	1	14.125"w x 38"h Gravitee Panel Frame
27	1	38"h Gravitee Corner Post
28	1	19"w x 38"h Gravitee Panel Frame
29	1	19"w x 38"h Gravitee Panel Frame
30	1	38"h Gravitee Corner Post
31	1	14.125"w x 38"h Gravitee Panel Frame
32	1	38"h Gravitee Corner Post w/ Door Attachment
1,2	1,1	37.0945"w Z45 Horizontal Extrusion
3	1	34.4173"h Z45 Vertical Extrusion

Steps:

- 1) Assemble Gravitee panels and posts in numerical order, as shown, making sure Velcro is facing inward. See Gravitee Panel Assembly sheet, for instruction.
- 2) Attach horizontal extrusions [1] and [2] between posts [25] and [32].
- 3) Attach vertical [3] between horizontals [1] and [2].
- 4) Connect doors to posts [25] and [32]. See **Door Connection** detail.

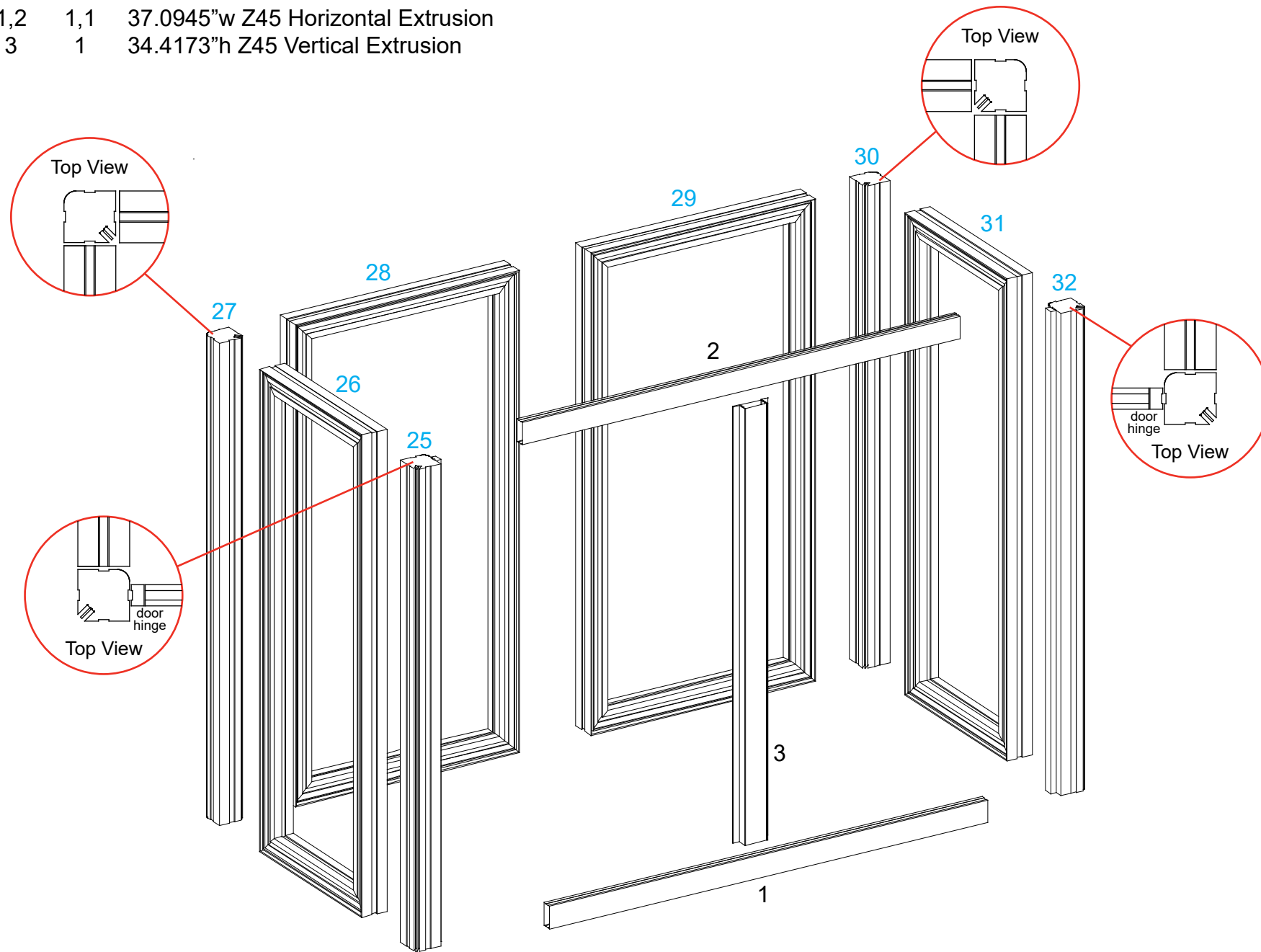
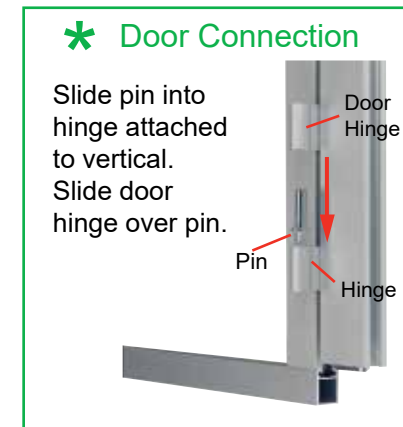

Back View

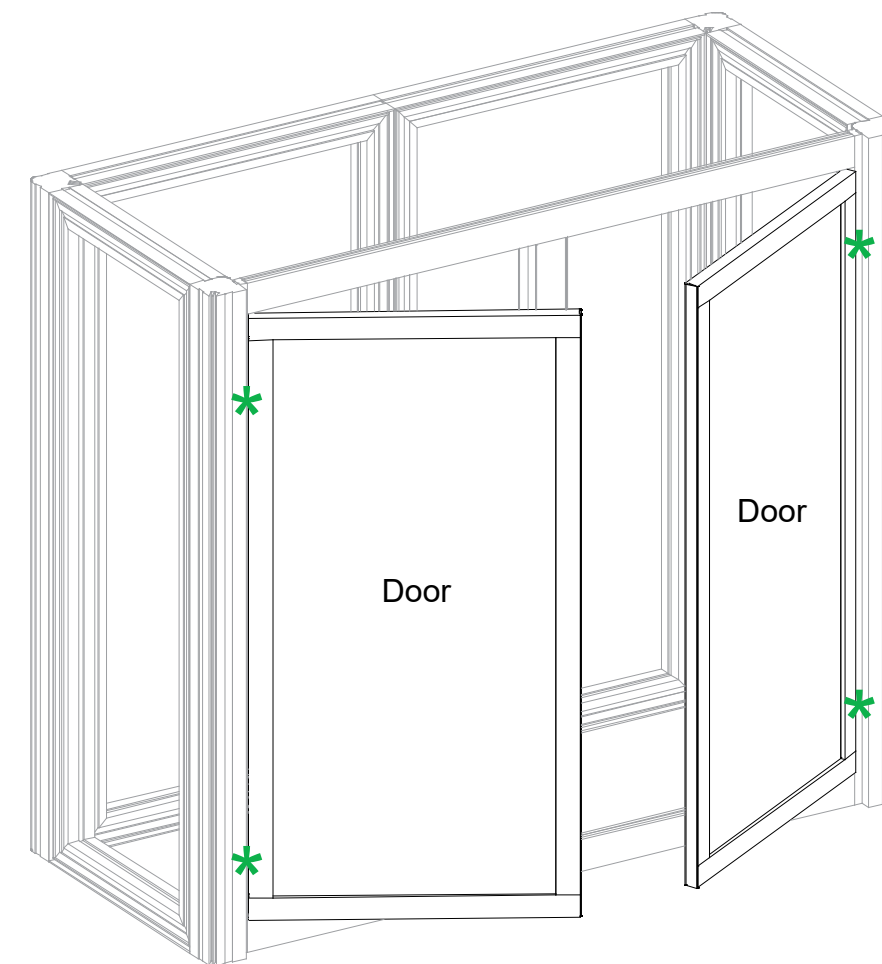

Back View

Steps:

- 1) Wrap **SEG Graphic** around front and sides of assembled counter.
See SEG Graphic Installation sheet for instruction.
- 2) Connect shelf supports to Velcro, then place shelf on top of supports.
- 3) Lock counter top to panels [26] and [31]. See **Counter Top Lock** detail.

Keep connectors [25] [32] extrusions [1] [2] [3] and doors assembled, when packing.

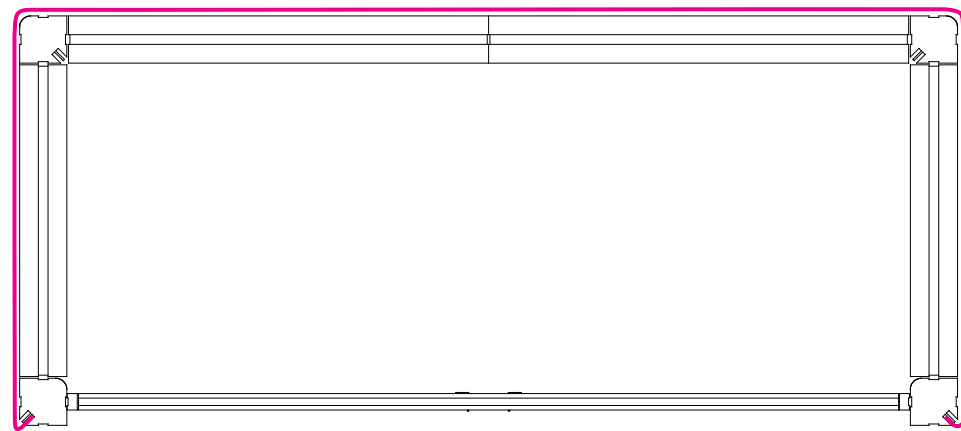

Top View

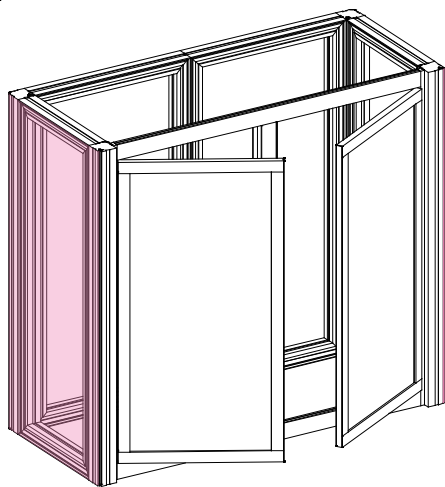

Back View

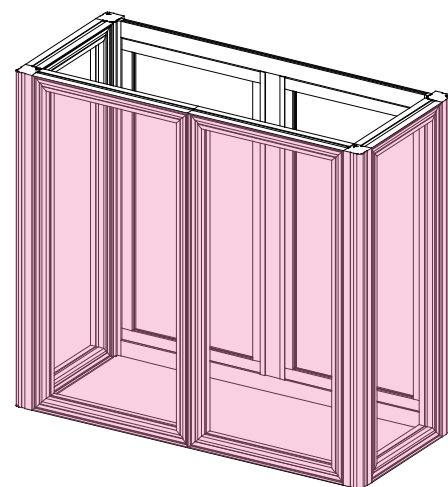

Front View

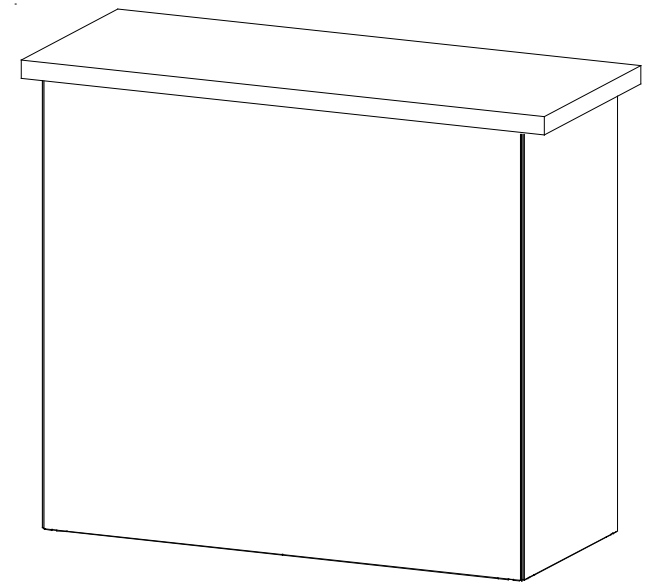
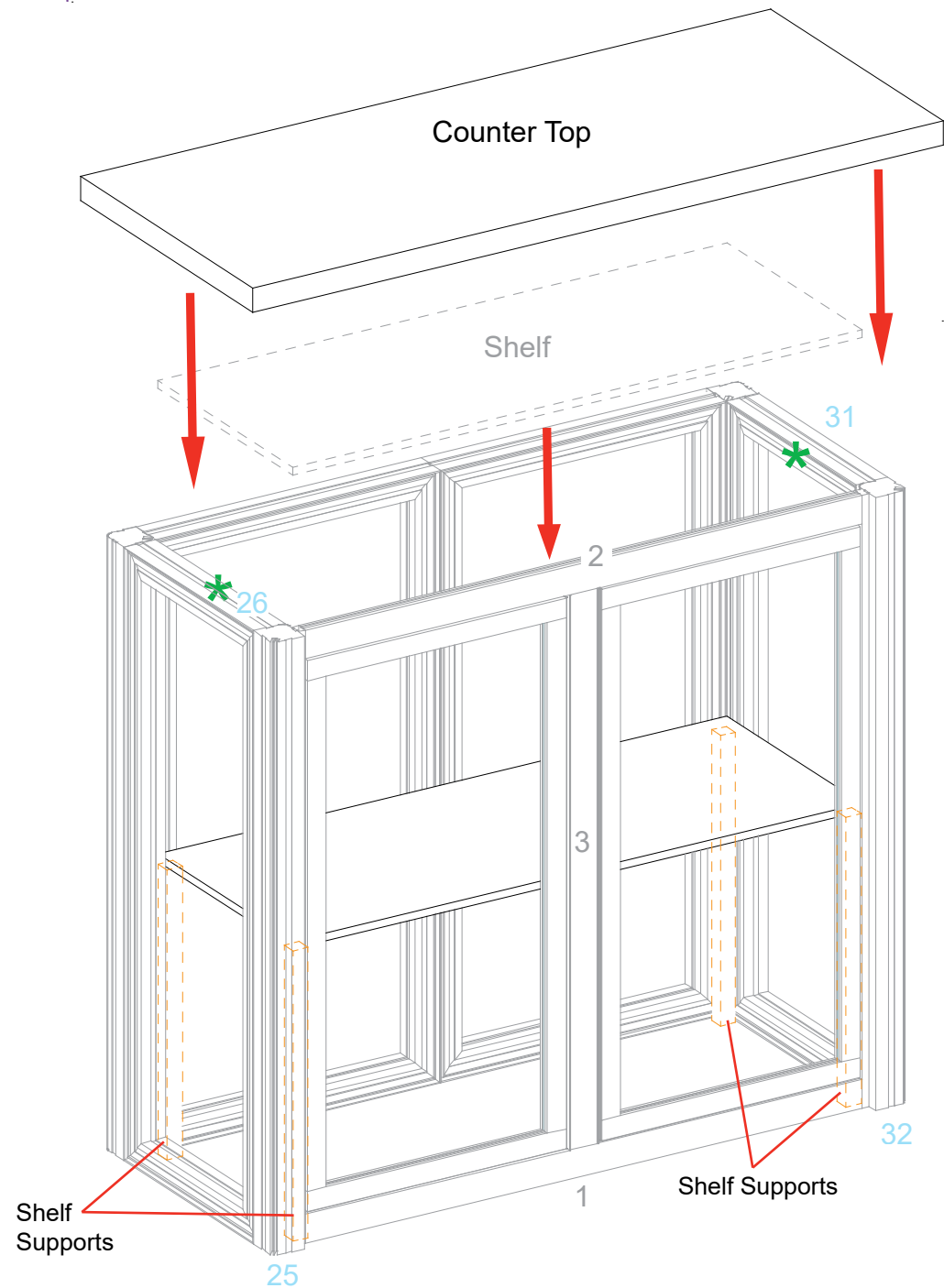

Completed Assembly

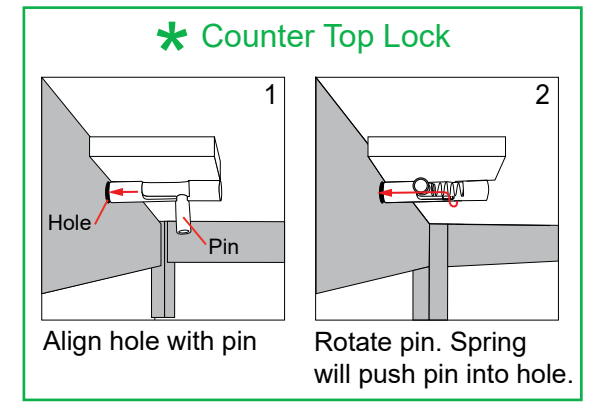

* Counter Top Lock

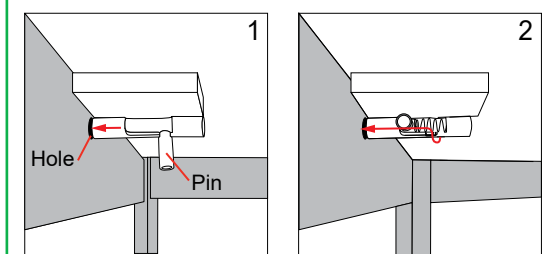

Align hole with pin Rotate pin. Spring will push pin into hole.